

Tuyaux Articulés 1/4" - Ø 6,35

ROSAGE



PETIT DÉBIT
Ø 6,35 mm
1/4"

Equipements 1/4"

Équipement standard

Longueur : 325 mm



40-413

20 segments
 3 buses rondes :
 Ø 1,6 - 3,2 - 6,35 mm
 2 raccords mâles : 1 en 1/4" et 1 en 1/8" NPT

Équipement complet

Longueur : 340 mm

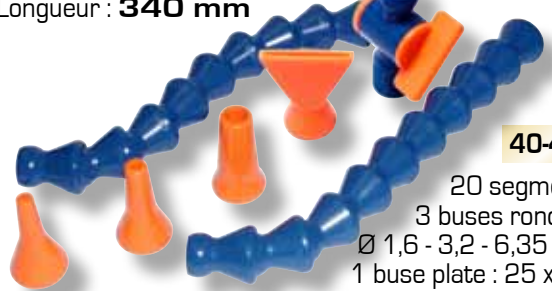

40-460

20 segments
 3 buses rondes :
 Ø 1,6 - 3,2 - 6,35 mm
 1 buse plate : 25 x 0,8
 1 robinet : 1/4" NPT mâle

COMMENT UTILISER LOC-LINE AU MIEUX

Ligne bleue et orange "Acétal"

Oui	Acétone
Non	Acides
Oui	Alcool, éthyle
Non	Solution ammoniacale (forte)
Non	Bases (fortes)
Oui	Détergents commerciaux
Oui	Essence
Oui	Graisses
Non	Solutions d'ions hypochlorites
Oui	Solvants pour vernis
Oui	Huiles
Oui	Huiles solubles
Oui	Soude caustique
Non	Chlorate de sodium



LOC-LINE 1/4" PETIT DEBIT

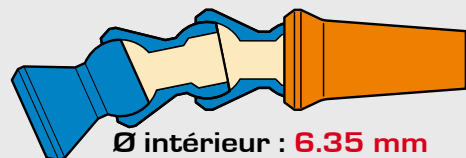

Ø intérieur : 6.35 mm

Pression maxi : 3.5 Bar

Débit : 15 litres / minute

Température d'utilisation maxi : 80°C

Raccords 1/8" et 1/4"

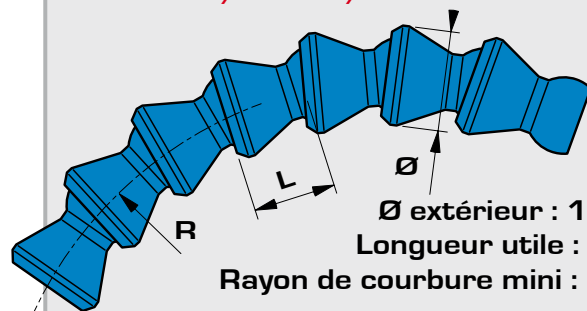

Ø extérieur : 16.25 mm

Longueur utile : 14.7 mm

Rayon de courbure mini : R 32 mm

Infos filetages

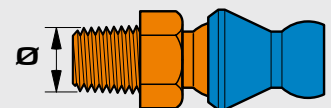

	NPT		BSP T	
	Filet à 60°		Filet à 55°	
	Ø extér. filets/pouce		Ø extér. filets/pouce	
1/8"	10 mm	28	10 mm	28
1/4"	13,5 mm	18	13,2 mm	19

Tuyaux Articulés 1/4" - Ø 6,35

Segments rotules

Segment standard

285 mm, (20 pièces)
1 mètre, (70 pièces)
7,5 m, 1 bobine
(525 pièces)
15 m, 1 bobine
(1050 pièces)

Réf. 

41-401
41-400
49-420
49-421

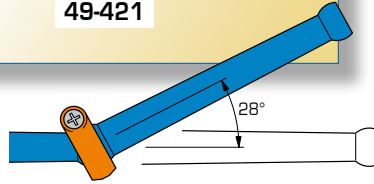
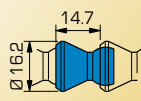

nouveau
Segment coudé long
flexibilité, rigidité

Segment long, 90 mm

Pochette de 4
Sachet de 20
Inclinaison :
28° maxi

Réf. 

41-476
49-445

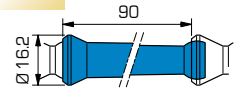

Anneau de rigidité

Pochette de 4
Sachet de 20

Réf. 

41-477
49-446

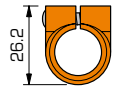

Assortiment

4 Segments longs, 4 Anneaux

41-475

Raccords filetés et Manchons taraudés

Raccord fileté

1/8" NPT

Pochette de 4
Sachet de 50



Réf. 

41-405
49-425

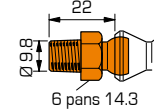

1/4" NPT

Pochette de 4
Sachet de 50



41-406
49-426

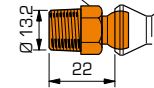

1/8" BSPT (Gaz)

Pochette de 4
Sachet de 50



41-417
49-437

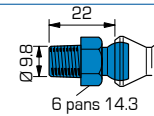

1/4" BSPT (Gaz)

Pochette de 4
Sachet de 50



41-418
49-438

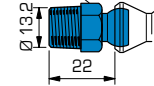

Manchon taraudé

1/8" NPT vers rotule femelle

Pochette de 4
Sachet de 20



Réf. 

41-411
49-431

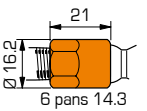

1/8" NPT vers 1/8" NPT

Pochette de 4



40-656

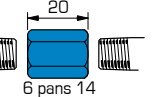

1/4" NPT vers 1/4" NPT

Pochette de 4



40-657

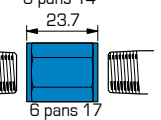

Réducteur

1/4" vers 1/8" NPT

Pochette de 4



40-655

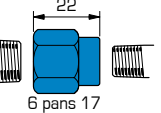

Robinetts et Segments spéciaux

Robinet

1/4" NPT mâle

Pochette de 2
Sachet de 10



Réf. 

21-192
29-452

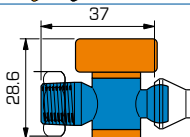

1/4" NPT femelle

Pochette de 2
Sachet de 10



21-193
29-453

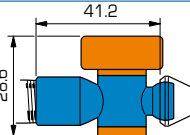

En ligne

Pochette de 2
Sachet de 10



21-194
29-454

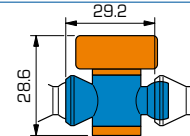

Métallique

1/4" BSPT
vers 1/4" BSPT
1 Robinet



40-310

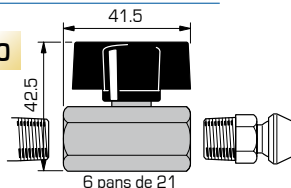

Valve anti-retour

Pochette de 2
Sachet de 10



Réf. 

21-191
29-451

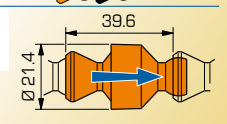

Stoppe l'écoulement de liquide lorsque la pompe est arrêtée. Le liquide est immédiatement disponible et réduit le fonctionnement à sec des outils. Débit minimum garanti : 95%

Segment à jet central

1 trou Ø 2 mm
Pochette de 4



Réf. 

41-478

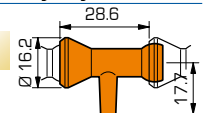

Bouchon obturateur

Pochette de 4



Réf.

41-480

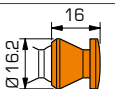

Cirque

Pochette comprenant :
15 Segments
1 Bouchon
Longueur : 446 mm
Ø mini inter : 92 mm

41-479



LOC-LINE noir disponible
sur commande 



Tuyaux Articulés 1/4" - Ø 6,35

Buses rondes

Buse ronde

1 trou Ø 1,6 mm
Pochette de 4
Sachet de 50



Réf. 

41-402
49-422

1 trou Ø 3,2 mm
Pochette de 4
Sachet de 50



41-403
49-423

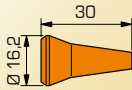

1 trou Ø 6,35 mm
Pochette de 4
Sachet de 50



41-404
49-424

Buse d'équerre

1 trou Ø 1,6 mm
Pochette de 4
Sachet de 20



Réf. 

41-470
49-439

1 trou Ø 3,2 mm
Pochette de 4
Sachet de 20



41-471
49-440

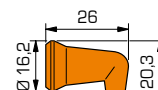

1 trou Ø 6,35 mm
Pochette de 4
Sachet de 20



41-472
49-441

Buses plates

Buse plate 25 x 0,8 mm

Pochette de 2
Sachet de 20



Réf. 

41-407
49-427

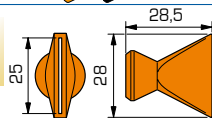

Buse 25 mm à Jet Concentré

Pochette de 2
Sachet de 20



41-489
49-456

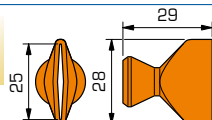

Buse plate 11 mm

11 x 1 mm
Pochette de 4
Sachet de 20



Réf. 

41-483
49-451

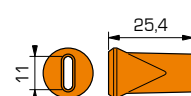

11 x 1,5 mm
Pochette de 4
Sachet de 20

41-484
49-452

Buses multi-jets

Buse orientable

16 trous Ø 1 mm

L : 38 mm

Pochette de 2
Sachet de 20



Réf. 

41-481
49-449

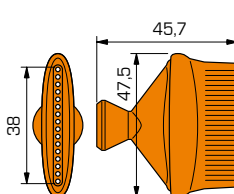

16 trous Ø 1,5 mm

L : 38 mm

Pochette de 2
Sachet de 20



41-482
49-450

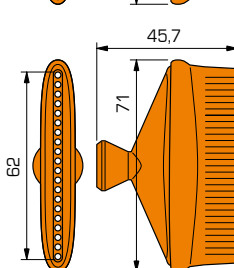

20 trous Ø 1,9 mm

L : 62 mm

Pochette de 2
Sachet de 20



41-488
49-455

Buse 11 mm

7 trous Ø 1 mm

Pochette de 4
Sachet de 20



Réf. 

41-486
49-454

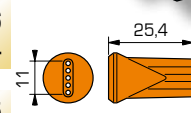

5 trous Ø 1,5 mm

Pochette de 4
Sachet de 20

41-485
49-453

Buse d'équerre

6 trous Ø 2,5 mm

Pochette de 2
Sachet de 20



Réf. 

41-473
49-442

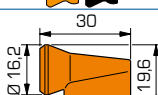

Pincés d'assemblage

1 Pince pour Loc-line 1/4"

2 Pincés : 1 en 1/4" et 1 en 1/2"

78-001

78-003

Utilisez le plus souvent possible pour assembler et déboîter le tuyau en toute sécurité.



Assortiments de Buses

Assortiment de 16 Buses

Pochette

 41-490

3 Buses rondes : Ø 1,6 - 3,2 - 6,35

3 Buses d'équerres : Ø 1,6 - 3,2 - 6,35

4 Buses plates : L 25 x 0,8 - 25 à jet concentré
L 11 x 1 - L 11 x 1,5

5 Buses multi-jets : 16 trous Ø 1 - 16 trous Ø 1,5

20 trous Ø 1,9

7 trous Ø 1 - 5 trous Ø 1,5

1 Buse d'équerre multi-jet : 6 trous Ø 2,5

Assortiment de 4 Buses d'équerres

Pochette de 4 buses

 41-474

Ø 1,6 - 3,2 - 6,35 - 6 trous Ø 2,5



Tuyaux Articulés 1/4" - Ø 6,35

Distributeurs et éléments de liaison

Élément de liaison Réf.

Dérivation en Y
1/4" vers 1/4"
Pochette de 2
Sachet de 20



41-408
49-428

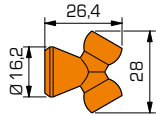

Manchon double
femelle
Pochette de 4
Sachet de 20



41-409
49-429

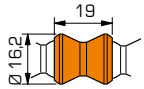

Coude mâle-femelle
1/4" vers 1/4"
Pochette de 2
Sachet de 20



41-415
49-435

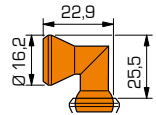

Dérivation en T
1/4" vers 1/4"
Pochette de 2
Sachet de 20



41-416
49-436

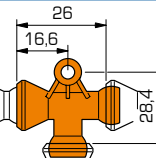

Support pour Manifold

Pochette de 2

21-195

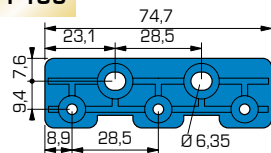

LOC-LINE noir disponible
sur commande 



Distributeur standard

Manifold

1 support avec vis
3 dérivation en té
1 coude mâle-femelle

21-199



Distributeur complet

Manifold

1 support avec vis
3 dérivation en té
1 coude
5 robinets en ligne

21-198

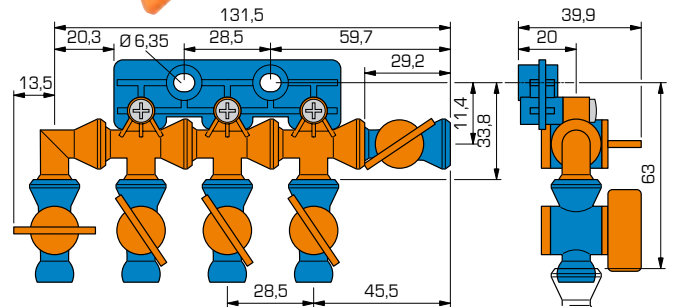

Distributeurs métalliques magnétiques

Gamme complète page 11

Support magnétique

1 corps aluminium anodisé
Ø 54 mm avec 4 sorties
1/4" NPT femelle
1 raccord tube
3 bouchons 1/4" NPT

40-305

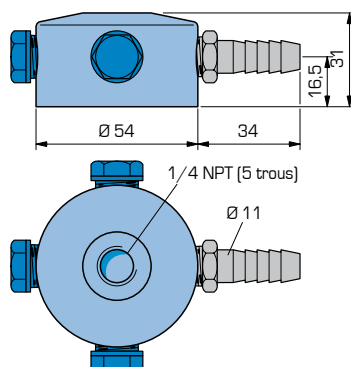

Support magnétique équipé

comprenant :

1 support 40-305
2 équipements 40-460

40-306

